

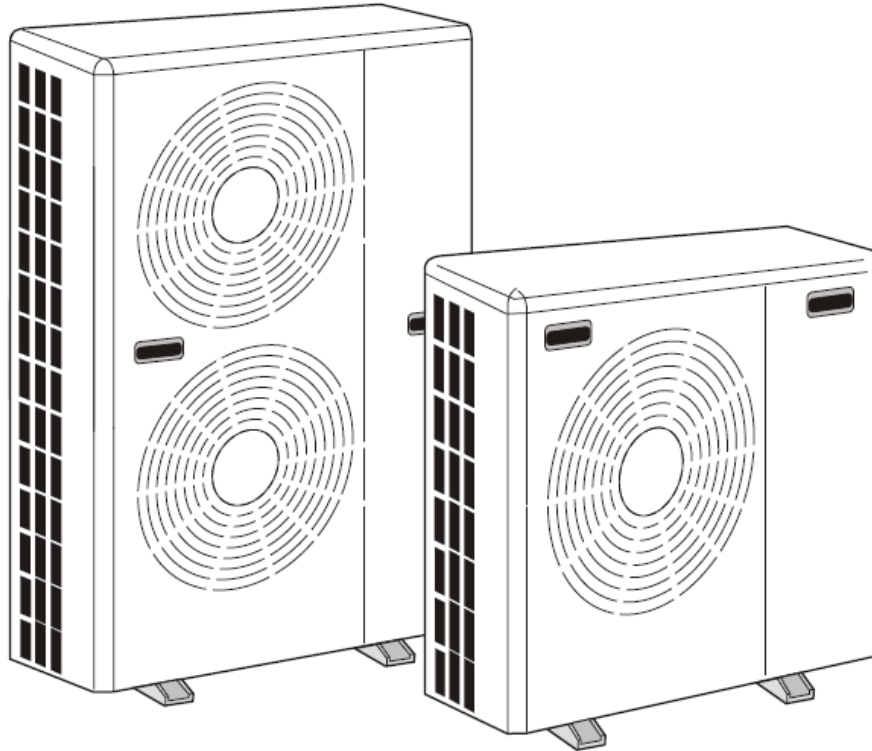

DC INVERTER MONOBLOCK AIR TO WATER HEAT PUMP AND CHILLER

User Manual



REV:UK-2018V9

Contents list

1. General -----	3
2. System description -----	3
3. Installation -----	3-10
4. Controller manual-----	11-19
5. Specification -----	19-21
6. Maintenance-----	22
7. How to get the most out of your heat pump-----	23

Safety notice

Never perform any cleaning operations before switching off the external isolator

Do not modify safety or control devices without consultation with the manufacturer

Do not pull, detach or twist the electrical cables coming from the unit

Do not introduce pointed objects through the grill and into the fan.

Important Notice for Antifreeze to Avoid heat pump broken

1. **Water flow switch MUST be installed** during installation for heat pump air conditioning side to ensure proper water flow.
2. **Must check if there is enough water flow after finish installation. You can check the inlet and outlet water temp difference must be about 5C when compressor is working in highest speed in heating mode.**
3. **Water filter MUST be installed** before water go into PLATE HEAT EXCHANGER. The water filter need to be cleaned at least half an year.
4. **Must use enough brine(glycol) in the water system in cold area.** if the air temp is lower than -0 °C, for the safety, you must use brine(glycol) as the fluid in the heat pump water system instead of pure water.
5. **MUST keep the electricity power supply always connected even when you don't use the heat pumps.** Our heat pump has antifreeze function if with electricity connected. So If without enough glycol (antifreeze liquid) and if the electricity is cut off by accident for more than 30 minutes in winter, you need to drain out all the inside water to protect the heat pump to be frozen.

1. GENERAL

The AH9/11/16 model is an air source heat pump for space heating and sanitary water heater for houses, apartment blocks and small industrial premises. Outdoor air is used as a heat source creating free energy to heat your home.

2. SYSTEM DESCRIPTION

The AH9/11/16 is a monoblock (single unit) air/water heat pump, specially designed for the colder climate. There is no need for bore holes and usually the system can be installed within 1 day.

The AH9/11/16 can both heat hot water effectively at high outdoor temperatures and give a high output to the heating system at low outdoor temperatures. If the outdoor temperature drops to a level lower than minus 0°C (factory setting), the auxiliary heater switches on to ensure the heat pump unit works normally. The unit is also capable of cooling in the summer. The heat pump controller is an intelligent wired system.

The AH9/11/16 is rated as 9KW/11KW/16KW. The Material/components are chosen to provide a long service life and to fully withstand harsh outdoor conditions.

AH9/11/16 has two different installation options:

- 1). Space heating/cooling + DHW (Domestic hot water)
- 2). Space heating/cooling only or DHW only

3. INSTALLATION

3.1: General points for installation engineer

3.1-1: Transport and storage

The unit should be transported and stored vertically.

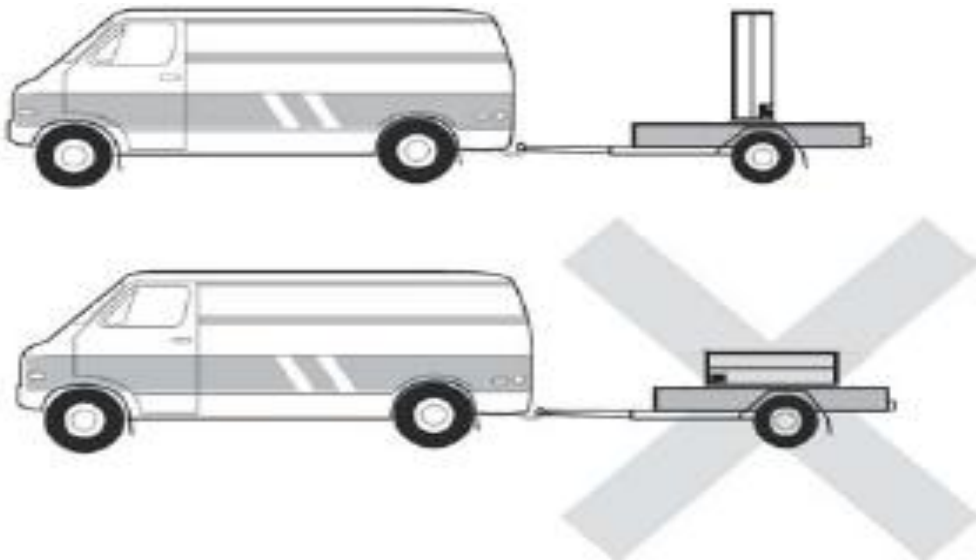

3.1-2: Inspection of the installation

Current regulations require the heating installation to be inspected before it is commissioned. The inspection must be carried out by a suitably qualified person and should be documented.

If the heat pump is replaced, the installation must be inspected again. In the event of installation with unvented (closed) heating systems, G3 unvented guidelines must be followed during the install. It should be noted that the heat pump provides the first measure of defense against high pressure/temperatures. A further 2 must be installed to comply with the G3 unvented procedures.

3.1-3: Siting the heat pump

The unit is placed (securely fixed) outdoors on a firm base, preferably a concrete foundation. It should not be positioned next to sensitive walls, for example, next to a bedroom. Also ensure that the placement does not inconvenience any neighbours'.

Large amounts of condensation water as well as de-icing water from defrosting can be produced. You must provide good drainage at the installation area and make sure the water cannot run out onto paths or the like during periods that ice can form. Ideally, condensation water is led off to a water drain or a suitable soak away. The distance between the unit and the exterior wall must be at least 350 mm. The free space above must be at least one meter. The unit must not be placed in a position so that air can re-circulate thus lowering the COP.

Care must be exercised so that the heat pump is not scratched during installation.

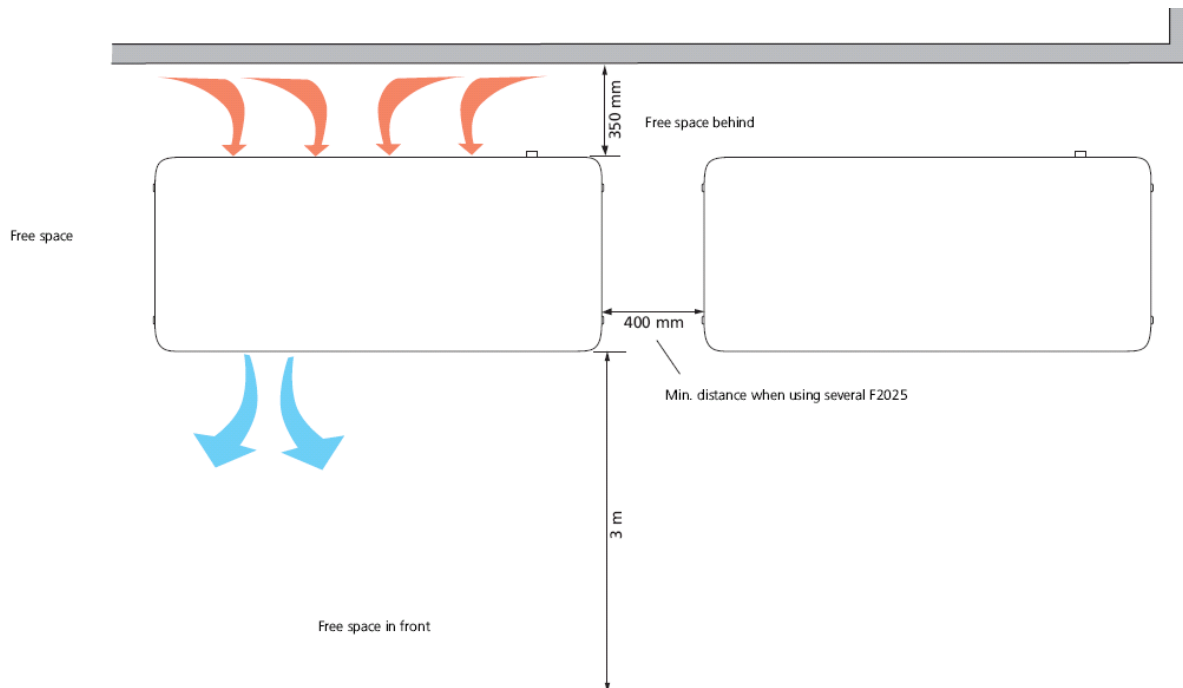

3.1-4: Controller:

The AH9/11/16 is equipped with an external electronic controller that handles all functions necessary for heat pump operations. Defrosting, stop at max/min temperature, connection of the compressor heater as well as enabling the aux electrical heater, monitoring of motor protection and pressure switches are all controlled.

The number of starts and the operating time can also be read.

The controller is set during installation and can be used during a service.

Under normal operating conditions the home owner does not need to have access to the controller. The AH9/11/16 has an integrated electronic outlet water temperature sensor that limits the outlet temperature up to 60°C.

3.2 Installation design

The AH9/11/16 can be installed in several different ways.

The safety equipment must be installed in accordance with current regulations for all installation options.

When connecting with the AH9/11/16, the total water volume in the heat pump pipe system and buffer tank must be at least 10 liters per KW of output.

A) Space Heating/Cooling + DHW

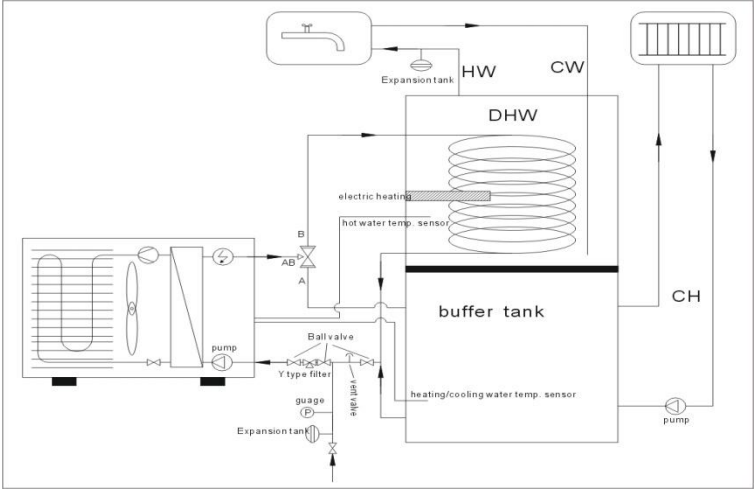

B). Space Heating/Cooling Mode Only

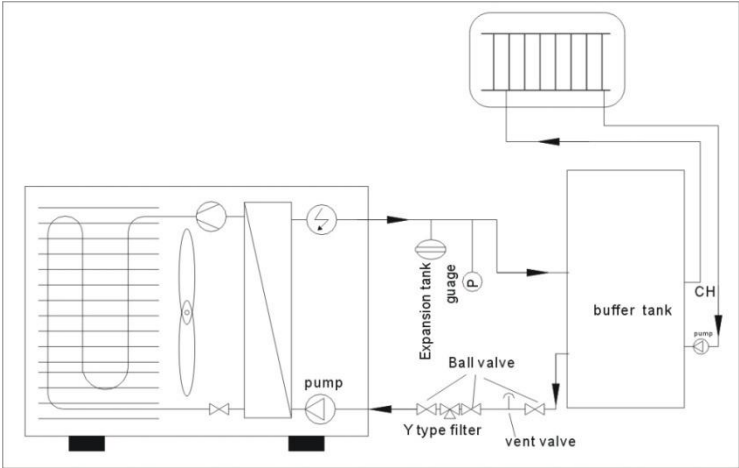

C) .2x 8/16/16 Installation. Space Heating/Cooling + DHW

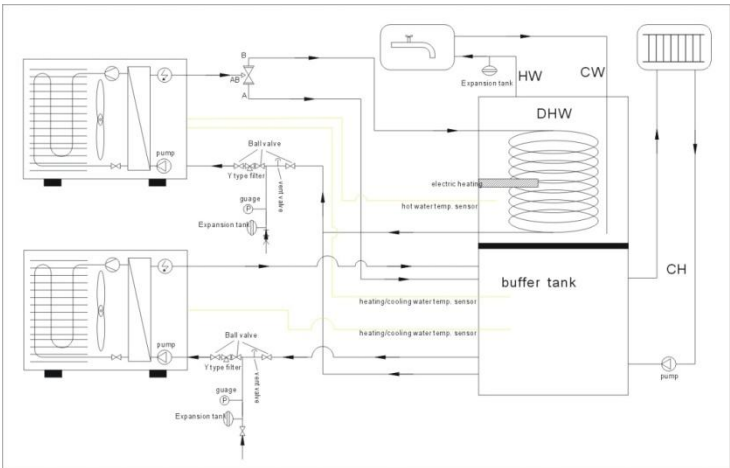

D). 3X8/112/16 Installation. Space Heating/Cooling + DHW.

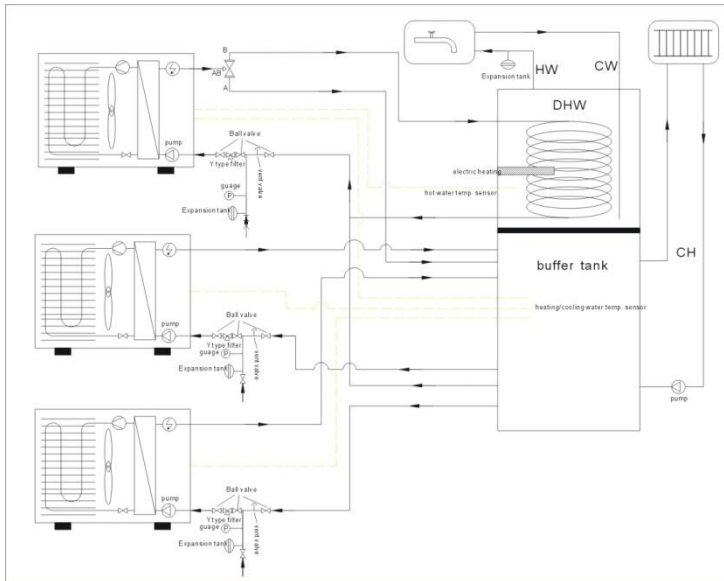

Solar Application 1

DHW with solar heating

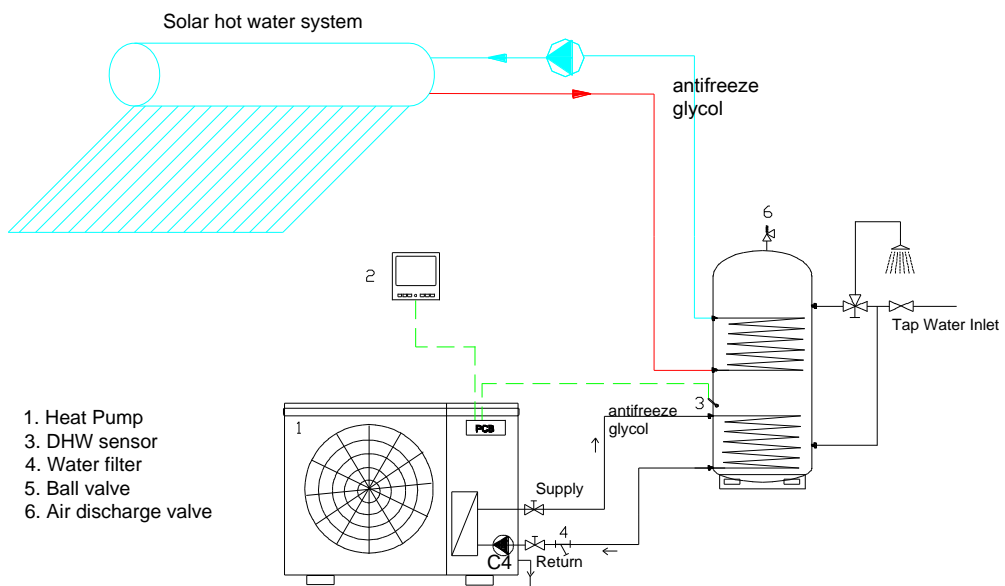

Solar Application 2

Application 2 Multifunctional heat pump with solar assistant DHW

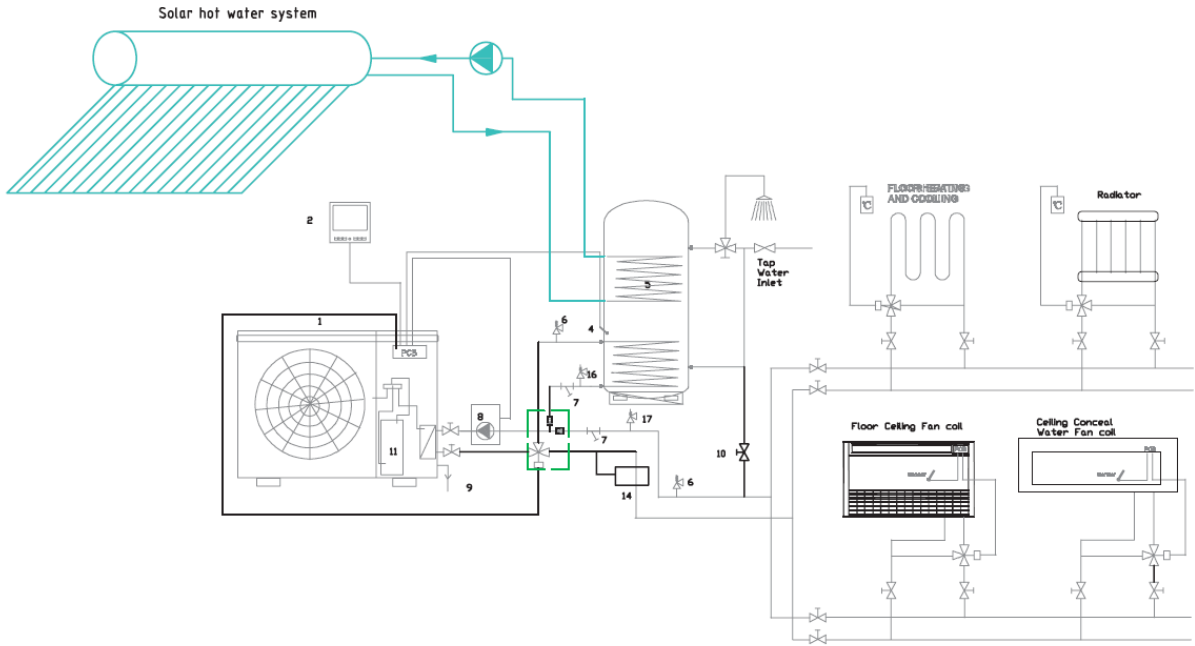

Solar Application 3 (Most saving to use solar for space heating and DHW)

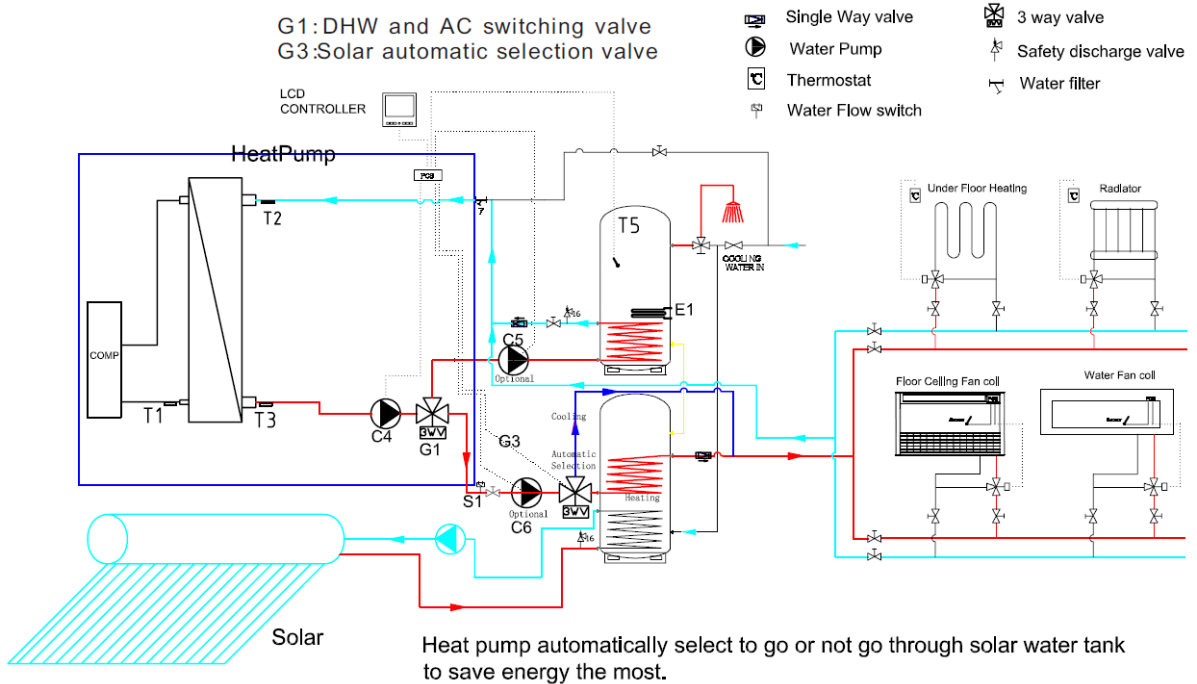

3.3 Pipe Connection

28mm pipe is recommended.

The pipe work must be flushed before the heat pump is connected, so that any contaminants do not damage the components parts.

The heating/cooling water inlet and outlet direction must be connected according to the marked areas on the heat pump.

All outdoor pipes must be thermally insulated with at least 19 mm thick pipe insulation. The insulation must also be vapor resistant.

The water circulation pump must at all times be operational (even if AH9/11/16 is not running) to prevent any possible damage due to freezing. Even when in standby mode, the circulation pump is controlled directly from the AH9/11/16, which takes the outdoor temperature and temperature in pipe into consideration to decide whether to circulate water within the system.

Shut-off valves and drain valves are fitted so that AH9/11/16 can be emptied in the event of prolonged power failures.

The supplied flexible hoses act as vibration dampers. The flexible hoses are fitted so a slight bend is created, thus acting as vibration dampening.

Important: Even though the AH9/11/16 has anti-freeze protection, if the circulation pump fails or there is a problem with the power supply, there is still a risk of damage due to freezing. During the installation Anti-freeze (Ethylene Glycol) must be used if the lowest air temp is lower than 0c in winter.

3.4 Electrical Connection

Electrical installation and service must be carried out under the supervision of a qualified electrician. Electrical installation and wiring must be carried out in accordance with the stipulations in force.

Wiring Diagram 1 phase

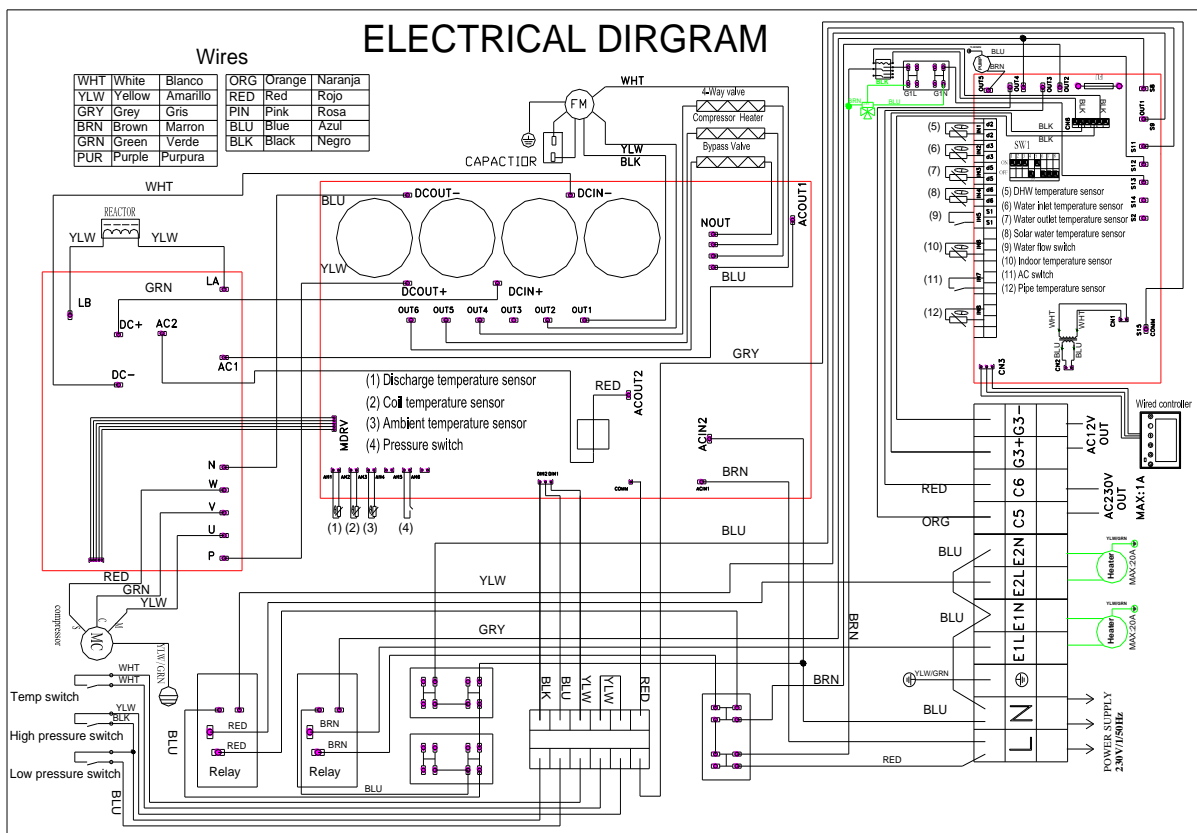

Wiring Diagram 3 Phase

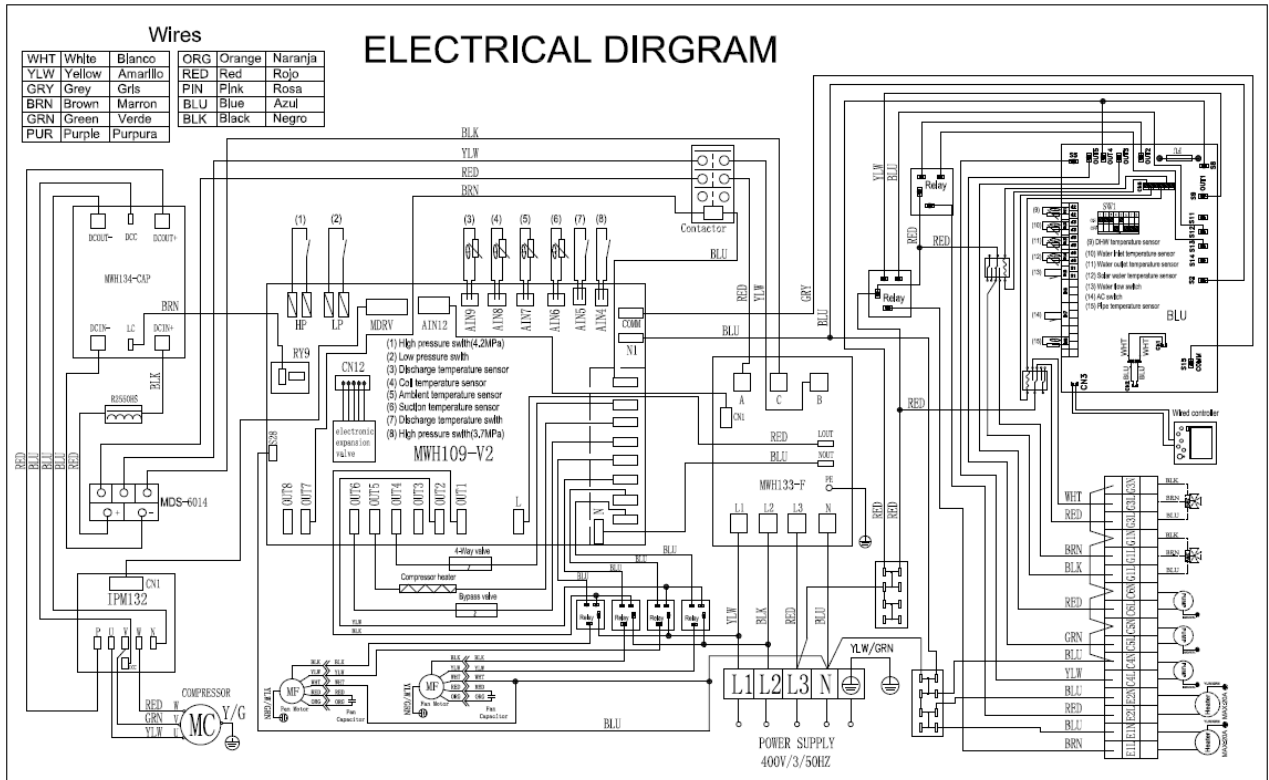

3.4-1: Installation Drawing

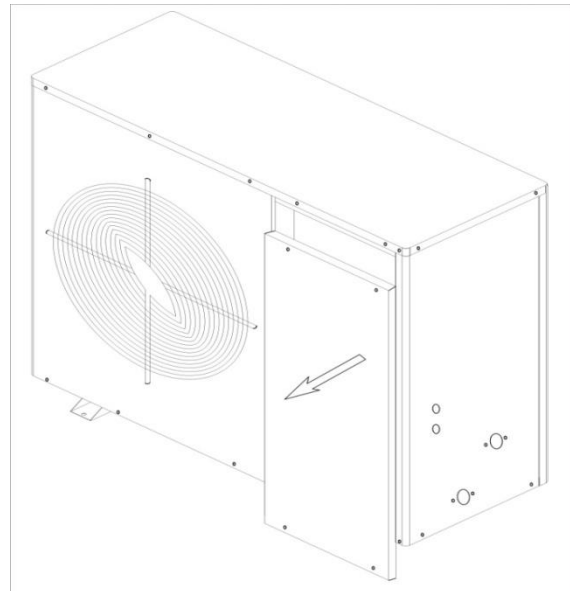
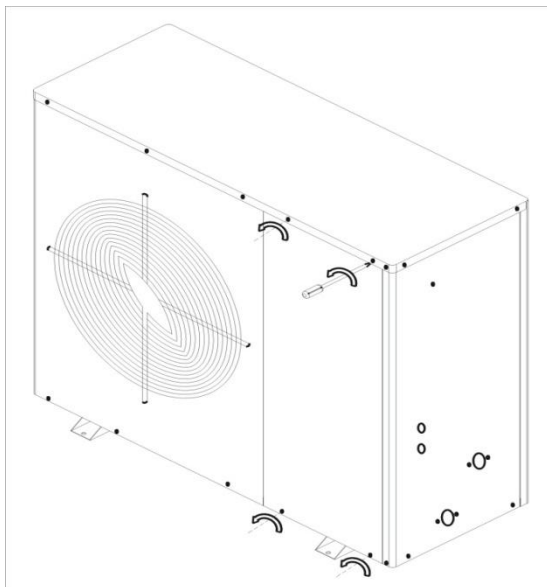

3.4.2 Important: You need to install a separate circuit breaker in all installations.

3.4-3: A Water Flow Switch must be installed to avoid plate heat exchanger broken.

A water flow switch must be installed at the water loop near the plate heat exchanger to protect the heat exchanger and compressor. Some of our units are already with built inside water flow meter switch. If you can see parameter C47 water flow volume, it means that you already have the water flow meter switch inside.

Water Flow Switch



1.If water system control PCB IN5 is connected with a short wire before, please remove this short wire.



2.Connect 2 wires of the water flow switch to IN5. Make sure they are connected and fasten tightly.



3.4-4: Anti-freeze Function

DHW anti-freeze

When DHW water tank(IN1) temperature $\leq 5^{\circ}\text{C}$, system starts hot water antifreeze, start domestic hot water mode and compressor, When hot water temperature is 20°C or higher, withdraw DHW antifreeze. If the compressor starts over 30 minutes, withdraw DHW antifreeze.

AC anti-freeze

Air conditioning inlet (IN2) or outlet (IN3) water temperature is 4°C or lower, system starts AC antifreeze, water pump C4 and C6 start, check ambient temperature one minute later.

- A、Ambient temperature $\leq 15^{\circ}\text{C}$, start compressor for heating
- B、Ambient temperature $\geq 15^{\circ}\text{C}$, only turn on water pump C4 and C6

When the input water temperature $\geq 10^{\circ}\text{C}$ or compressor operates over 30 minutes , withdraw AC antifreeze.

When anti-freezing, if water temperature reduced to 1°C or lower, machine will stop and error code Pd display.

3.5 COMMISSIONING

3.5-1: Preparations

Before commissioning, make sure compressor heater has already pre-heated for 3-10 minutes.

1) Compressor Heater

As mentioned above, if the temperature is lower than 20°C , it is important that the compressor heater can heat the compressor before the first start up. In order to ensure this happens, please follow the instructions below:

- a. Disconnect the power connection of compressor, aux electric heater, circulation pump. (Due to anti-freeze protection, the compressor, aux electric heater and circulation pump could start in stand-by status.
- b. Switch on the outside Isolator and power connection of the unit.
- c. After 3-10 minutes, switch off the outside Isolator and re-connect the power connection of compressor, aux electric heater and circulation pump.

2) Filling and Venting

Fill the system slowly ensuring bleed valves are open (if not automatic).

3.5-2: Inspection Before Start up

1) Mechanical Inspection:

- a. Check the cabinet and inside pipe system for possible damage during transportation.
- b. Check that the heating water circuit is filled and well vented. Check the pipe system for leaks.
- c. Check the Fan making sure it can move freely.

2) Electric System Inspection

- a. Check the power supply (voltage/frequency) matches the rating label and specification.
- b. Check all the electrical connections for loose or damaged wires due to transportation.

3) Pipe Inspection

- a. Check all the valves, and water flow directions.
- b. Check for any possible leaks inside or outside of unit.
- c. Check the insulation of all the pipes.

3.5-3: Start up and Commissioning

- a. After the system inspection is finished, startup can begin.
- b. Connect the power supply; switch on the isolator to turn on the heat pump.
- c. The circulation pumps starts immediately. After 30 seconds, the fan motor starts. After another 10 seconds, compressor starts.
- d. Air is initially released from the hot water and venting may be necessary. If bubbling sounds can be heard from the heat pump, the circulation pump or radiators the entire system will require further venting. When the system is stable (correct pressure and all air eliminated) the automatic heating control system can be set as required.
- e. Check heating water inlet/outlet temperature difference after the system is stable.
- f. Check the compressor exhaust and suction temperature.
- g. Adjust the parameters according to different weather conditions and user requirements.

4. CONTROLLER MANUAL

4.1: Electric Parts Control Program working theory

a). Compressor

- After the compressor is shut down, it has a minimum interval of 3 minutes before the next start up
- The initial "power-up" does not require the protection of three minutes;
- During defrost, compress on/off interval is based on the defrost parameters.

b) Start up/Shut down Cycle

- When the heat pump switches on, the water circulation pump and the fan will start 60 seconds before compressor
- When the heat pump switches off, the water circulation pump shuts down 30 seconds after the compressor. The fan switches off 5 seconds after the compressor
- During defrost, the water circulation pump does not stop running;

c) **2nd heat source starting**

When parameter P27= 0, E2 is AC heating control port, When parameter P27 = 1, E2 is 2nd heat source control port

d) **DHW Auxiliary Electric Heater E1**

When parameter P27 = "1", When E2 not start, E1 will work as normal DHW assistant heater. When E2 start, E1 will be off.

When P27="0", the auxiliary electric heater **E1** turns on as set out in the conditions below:

- Ambient temperature \leq set value (parameter P09,-20 °C ~ 30 °C, default 0 °C);
- Compressor's working time \geq 15 minutes;
- DHW water tank temperature $<$ setting temperature;

When start defrost mode at DHW mode, E1 will be on if DHW temp<38c. when DHW temp>42c, E1 off.

When DHW antifreeze, E1 is on, when DH>15C, E1 off.

When some error cause compressor stop, if DHW required, E1 will be on.

e) **Multifunctional port E2**

When parameter P27= "1", E2 is for 2nd heat source control

A, if Ambient temperature $<$ set value (parameter P28),

E2 On, heat pump standby.

B, if Ambient temperature \geq set value (parameter P28, default -15 °C),

E2 Off, heat pump start working.

When P27="0" **E2** is for AC auxiliary electric heater.

E2 turns on as set out in the conditions below:

- When the heat pump is running AC heating or DHW but some error happen to stop compressor, the auxiliary electric heater E2 will start together with E1.
- When the heat pump is running AC heating:
 - A, When the heat pump runs AC heating normally, the auxiliary electric heater **E2** turns on as set out in the conditions below:
 - Ambient temperature \leq set value (parameter P10);
 - Compressor's working time \geq 15minutes;
 - AC water inlet temperature+3C $<$ target inlet water temperature;

B, When start defrost at AC heating mode, if inlet water temperature \leq 25 °C, **E2** turns on. When Ac inlet temp>30c, E2 off.

C, During AC antifreezing, the auxiliary electric heater **E2** turns on.

D, If inlet or outlet temperature sensor breakdown, the auxiliary electric heater **E2** turns on.

f) **Motorized 3 way Valve G2**

In DHW mode, the motorized 3 way valve is power on. In any other mode, it is power off.

4.2: .Operating Mode Principle

1) Space Cooling Mode

Temperature setting range is 10-25 °C, the factory setting is 12 °C;

2) Space Heating Mode

Temperature setting range is 10-55 °C, the factory setting is 45°C;

3) Hot Water Mode

Temperature setting range is 10-60 °C(50~60c is increased by electric heater), the factory setting is 50 °C;

4) Defrost Cycle

Auto Defrost mode (normal defrosting)

All heat pumps are fitted with intelligent defrost controls. A number of parameters are taken into account before defrost begins and ends. The parameters should be set as per factory settings or

otherwise set out by a engineer. The defrost time will vary depending upon the conditions the heat pump is working in. The length between defrosts will either extend or contract depending upon the parameters set.

4.3.1、 wire controller

There are 6 keys for operation. Auto restart function, weekly timer.

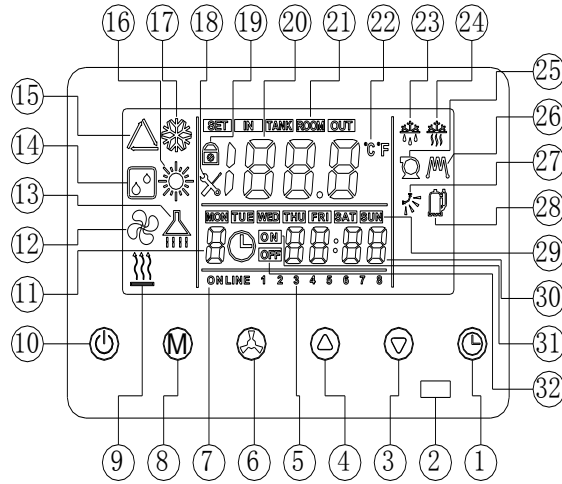

4.3.2、 Buttons definition

- (1) clock: Change the clock and timer
- (3) down key: reduce
- (4) up key: increase
- (6) confirm key: confirm the setting
- (M) mode key: change the mode
- (10) on off key: Turn on or off heat pump

4.3.3、 icon definition

Item	Icon meaning	Item	Icon meaning	Item	Icon meaning
5	Pending	7	pending	9	pending
11	timer period	12	GH water pump or fan motor	13	DHW
14	Sterilization	15	auto mode	16	room heating
17	cooling	18	service icon	19	lock icon
20	Temp	21	Indicating temp location	22	temp unit
23	Defrost icon	24	anti freeze	25	indoor water pump
26	e-heater	27		28	compressor icon
29	week display	30	time display	31	timer on icon
32	timer off icon				

4.4、 keys operation

4.4.1 change mode (7 modes)

A、 under mode standby or on, press the M, press the M key repeatedly, the following icons will flash by recycling.

AC AUTO (15) ; COOLING (17) ; HEATING (16) ; DOMESTIC HOT WATER (13) ; AC AUTO (15) & HOT WATER (13) TOGETHER; COOLING (17) & DOMESTIC HOT WATER TOGETHER (13) ; HEATING (16) AND DOMESTIC HOT WATER TOGETHER (13) ; COOLING AUTO (14).

B, When selected cooling or heating plus DHW, DHW will be priority.







C, When selected DHW mode, only DHW operation, no cooling and heating.

D, Healthy sterilization is an independent automatic operation mode, if necessary, modify the parameters individually.





4.4.2 Modify the setting parameters

A, When the selected mode is running, the unit will run in accordance with the factory set default values or the last modification of the temperature.

B, The modification method of set the temperature value

In the On or Standby cases, press M and  keys at the same time 3 seconds, the current operation mode flashes; by pressing the M key, you can switch the sequence in the following order: cooling/heating/DHW; Press , the number will flash, then press the  or  to change set up fixed value, press  key to confirm change and press  to exit . If not press , it will quit automatically after 15 seconds without saving amendment.















C, The detailed settings in the table below

Item	meaning	Setting range	default	Change setting date
1	AC cooling	10°C ~25°C	12°C	M+  →M→  or  →  → 
2	AC heating	(AU)10°C ~55°C	45°C	
3	Hot water	(AU)10°C ~60°C	50°C	
4	Antibacterial	60°C ~70°C	65°C	

D、 Antibacterial setting

Time setting procedure for health sterilization

Only in sanitary hot water mode, health sterilization will work. If sanitary hot water mode off, health sterilization will fail to work.

In on or standby mode, first, press key M and  for 3 seconds, second, press key M ,15 icon appears, then press the  or  to set sterilization temperature, press key  to confirm, the number of days will flash and show the original or default value 7 (that means 7 days), press key  or  to increase or decrease the number of days at predetermined intervals, the minimum of 7 days, maximum of no more than 99 days, after that ,press key  to confirm. At this time, "ON" character appears, "hour" appears and flashes, show the original setting or the default value (default value 01 means it will start at 1:00 am), followed by press key  or  to modify (0-23) ,after that, press key  to confirm, then the new time start running. "ON" character disappears, "OFF" character appears, "minute" value flashes and shows the original or default value (default value is 10), followed by press key  or  to change (minimum is 10, maximum no more than 99), after that press key  to confirm and exit change mode. If didn't press key  to confirm, machine will exit change mode automatically after 15 seconds. But settings did right now will become invalid.

4.4.3、 clock setting

press  key, week icon flash, :

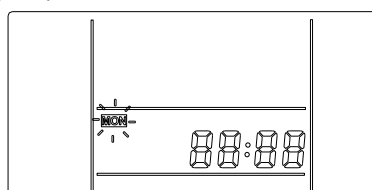

press ▲ ▼ to set the date, press Ⓞ for confirmation。 Then the hour digit flash. As below:

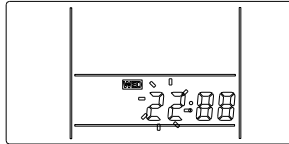

press ▲ ▼ to set the date, press Ⓞ for confirmation。 Then the minute digit flash. As below:

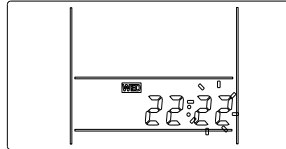

press ▲ ▼ to set the date, press Ⓞ for confirmation。 Then exit.

4.4.4、 timer setting

One day can set 3 points for on, 3 points for off . Point 1、 3、 5 is on, can set the working mode, 2、 4、 6 is off.

Only when timer is set, it will display the timer on and timer off icon on the display.

A、 : timer setting for turn on (timer points 1,3,5)

(1) Press Ⓞ key for 5 seconds, enter timer setting mode, week icon SUN flash, press up or down key to select and press Ⓞ to confirm. After confirmation, timer period number 1 flash, press up and down key select the setting period, press Ⓞ to confirm. Hour number flash as below:

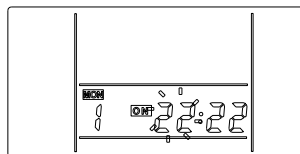

(2) Press up and down key to select number of hour, press Ⓞ to confirm. After confirmation, minute number flash, press up and down key to select, press Ⓞ to confirm. AC mode icon flash, as below:

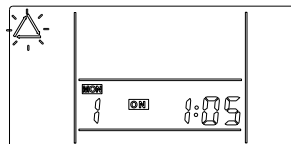

press up and down key to select mode, press Ⓞ to confirm. After confirmation, timer on icon flash Ⓞ as below:

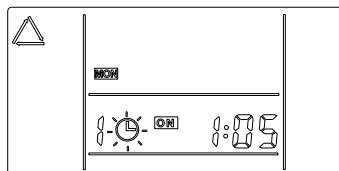



Press ▲ key, timer icon Ⓞ become solid, means this timer is valid. Then press Ⓞ to confirm and quit . When timer icon Ⓞ is flashing , the timer is not valid. When timer icon is solid, if press ▲ key again, the timer icon will become flashing again. If timer icon is flashing and press Ⓞ to quit timer setting. The current timer will not be confirmed.

(3) Timer points 2,4,6 setting for timer off.

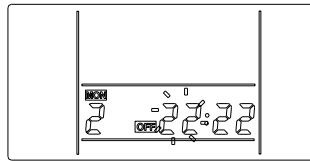
Enter timer setting, select week, and time point 2, press  to confirm. Hour icon flash, as below:



(4) Press up and down key to select hour number. Press  to confirm, then minute icon flash. Press up and down to select minutes number. Press  to confirm.

Timer setting is valid, icon flash, as below.

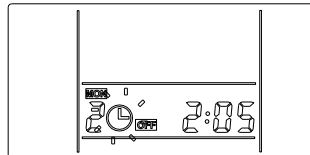

(5) Press up key, timer icon is solid, means setting is valid, press  to confirm. Press up key again, timer icon is flashing, means the setting is not valid.

(6) Press up and  key at the same time for 3 seconds, all the timer setting will be cleared.

4.4.5、 Night mode

(1) Night mode valid or not is up to parameter P47. If the data is set 0, means off, 1 means on. The night mode starting time is decided by data 48. Ending time is decided by data 49.

(2) With night mode, hot water mode will run with the current setting temp +3C, room heating run with current setting -2C. Room cooling run with current setting +2C. Outdoor fan run at low speed.

4.4.7 Auto Heating Target Curve Function:

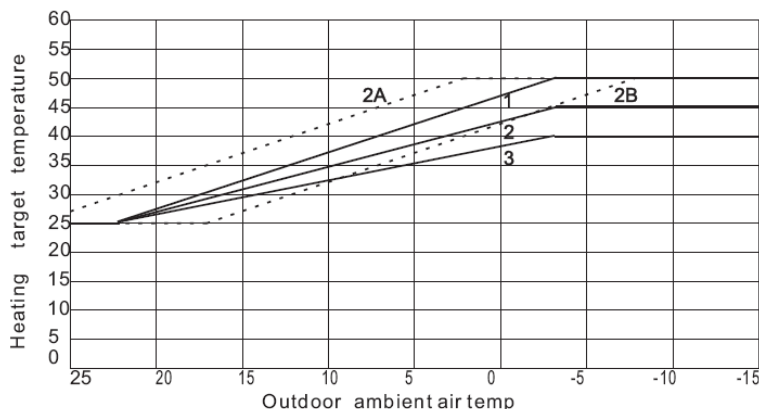

- First need to set the AC heating target temp to "AU". When you keep pressing LCD controller "Down arrow" button until it show "10", then press "Down" one more time, it will show "AU".
- AU curve offset shift temp is adjusted by parameter(P45), positive value means move up, negative value means move down. (-15~15C)
- AC AU heat curve highest temp is set by parameter (P46), range 30~50C, default 45C. When the parameter is 45C, the AU highest target temp is 45c.

4.4.8 communication with LCD controller

LCD controlled is connected with heat pump CN3 by 3 wires,(must in order) max 100m.

4.5. System Protection and Error Codes

If error, unit display“Ex” “Px” or“Fx”。 For example: E2、 P5

code	meaning	LED2	remark
E1	compressor overheat or discharge high temp protection	red and flash	Decided by outdoor unit
E2	Outdoor air temp sensor error	Flash 3 times	Outdoor air temp sensor open circuit or short circuit
E3	pipe or return air temp sensor error	Flash 6 times	(1)temp sensor open circuit or short circuit (2) suck sensor open or short circuit
E4	AC return water temp sensor error	red and flash	Stop compressor when running AC
E5	AC leaving water temp sensor error	red and flash	Stop compressor when running AC
E6	DHW temp sensor error	red and flash	Stop compressor when running AC
E7	solar water temp sensor error	As normal	Not stop compressor
E8	fan coil high temp protection	red and flash	Water source anti freeze protection
E9	system anti freeze twice	red and flash	Stop compressor
EA	DHW anti freeze twice	red and flash	Stop compressor
EB	indoor refrigerant pipe sensor error	No flash	Temp sensor open circuit or short circuit
EC	water source inlet water sensor error	No flash	Temp sensor open circuit or short circuit
ED	water source leaving temp sensor	No flash	Temp sensor open circuit or short circuit
EE	water source anti freeze protection	No flash	1.Water source heat exchange not efficient or water source temp too low 2.Water source water flow volume not enough
EF	water source water flow not enough	No flash	Water source water flow volume not enough
EG	Indoor ambient sensor error	No flash	Temp sensor open circuit or short circuit
F1	aaavoltage protection	Flash 1 time	Voltage is too high or too low, heat pump will recover when voltage be normal (165~265VAC)
F2	power module PFC error	Red and flash	IPM module error or wire connection wrong
F3	compressor abnormal stop	Red and flash	compressor stops abnormally
F4	outdoor module radiator sensor error	Flash 5 time	Temp sensor open circuit or short circuit
F5	outdoor current sensor error	Flash 8 time	Current sensor fault or no test wire cross it
F6	IPM error or Module control board error	Red and flash	Communication not good or IPM module fault
F7	compressor fail to start up	Red and flash	Compressor cannot start properly
F8	outdoor over current	Red and flash	Compressor current is too high
F9	Discharge sensor error	Flash 7 time	Temp sensor open circuit or short circuit
FA	Outdoor module overheat, over current	Flash 5 time	IPM module temp too high or compressor current too high
FB /E8	outdoor coil over heat	Flash 15 time	Outdoor heat exchange not good
P1	high pressure protection	Flash 2 time	1.refrigerant volume too much 2.throtting part error, 3. High pressure switch error
P2	low pressure protection	Flash 9 time	1.refrigerant volume too little 2.throtting part error, 3. low pressure switch error
P3	compressor discharge air over heat protection	Flash 10 time	1.Refrigerant too little, 2.throtting part error
P4	over current protection	Flash 11 time	1.refrigerant volume too much 2.throtting part error, 3. Current sensor error
P5	indoor unit water flow error	No flash	1.Water flow volume too small 2. Water flow switch error
P6	outdoor water flow error (For GH)	Flash 17 time	1.Water source side waterflow volume too small 2. Water source side Water flow switch error
P7	miss phase	Red and flash	Power supply error
P8	wrong phase	Red and flash	power supply error
P9	communication error	Red and flash	Communication wire open or PCB error

4.6 : System Adjustable Parameter Table

Press M+ ▲ key on wire controller for 3 seconds, it will show PXX to check and set the data

Code	name	Range	default	Remark
P00	Auto restart (after power supply, unit come back to the previous working mode before power cut off)	0: off; 1: on	1	

P01	DHW hot water temp differentia	2~15℃, minus differentia	2℃	
P02	AC temp differentia	2~15℃, minus differentia	2℃	
P03	Coil copper pipe temp to active defrost	-20~5℃	0℃	
P04	water source side anti freeze temp (for Geo heat pump)	-20~5℃	2℃	
P06	Coil copper pipe temp to stop defrost	10~35℃	30℃	
P07	defrost time (defrost action lasting max time, will stop defrost if longer than this value)	15~99 minutes	15	
P08	defrost interval time (time between 2defrosts, less than this value, it will not defrost)	15~99 minutes	35	
P09	ambient temp to activate hot water e-heater	-20~20℃	0℃	
P10	ambient temp to activate AC e-heater	-20~20℃	0℃	
P11	DHW frequency limitation percentage on max frequency. (If heat pump max is 90HZ, p11=9, DHW only run 81hz)	2~10, (equal to the highest frequency 20~100%)	10	
P12	compressor discharge air protection temp (higher than the setting, it will protect)	100~127℃	115℃	
P13	defrost interval multiple times control (if P08=35minutes, P13=2, interval between defrost will be 35*2=70Minutes)	0: no defrost; 1~4; defrost interval time multiple rate	1	
P14	functional parameter (to control seasonal valve and solar valve, UK may not use it)	0: G3 is seasonal switching valve; 1: G3 is solar valve ;	0	
P19	running with fixed frequency (for factory testing only)	10~100 HZ	50HZ	
P20	running frequency setting(for factory only)	0: manual frequency; 1: auto running frequency	1	
P21	EEV manually initial open degree (heating) /2	50~240 (Only valid when P23=3)	175	
P22	EEV manually initial open degree (cooling)/2	50~240(Only valid when P23=3)	175	
P23	EEV control mode	0—no; 1—checking; 2—manual; 3—auto for factory only	0	
P24	EEV Temp differential to stop the valve (heating)	-5~10℃ for factory only	0℃	
P25	EEV temp differential to stop the valve (cooling)	-5~10℃ for factory only	0℃	
P26	water pump working mode	0(no stop), 1 (stop when reach temp), 2 (running 1 minute every 15minutes)	1	
P27	second heat source validation	0 (no), 1 (yes)	0	
P28	starting air temp for second heat source	-30~15℃(On when lower than this)	-15℃	
P29	room target setting temp	10-28℃	21℃	(H)
P30	buffer tank highest temp	35-55℃	45℃	(G)
P31	buffer tank lowest temp	15-30℃	25℃	(L)
P32	water temp adjust range	1-5℃	2℃	(F)
P33	water temp adjust interval	20-255min	120min	(I)
P34	longest counting period	6-48H	24H	(J)
P35	target water temp modification value	-2℃-5℃	2℃	(E)
P36	ambient temp correction factor X100	10-200	75	(C)
P37	starting ambient temp for calculation	-7-15℃	7℃	(B)
P38	temp differential to reduce frequency	4-15℃	7℃	(T)
P39	target of low frequency(when reach the setting of P38, it will reduce to the P39/100 of the highest)	15-90	15	(U)
P40	monitoring interval (to adjust frequency)	1-15min	2min	(V)
P41	temp interval (increase or decrease base on this setting. Every P40 minutes when reach P41 C/2, will change frequency)	1-4℃	1℃	(W)
P42	increase frequency adjustmentX100	2-50(%)	15	(S)
P43	decrease frequency adjustment X100	2-50 (%)	15	(Y)
P44	target temp tolerance	1-3℃	2℃	(Z)
P45	AC AU curve offset value (our weather compensation curve AU)	-15~15℃	0℃	
P46	AC AU curve max temp value (our AU)	30~50℃	45℃	
P47	night mode validation (night mode: DHW increase 3C, AC temp reduce 2C)	0 (off), 1 (on)	0	
P48	night mode starting point	0-23 (time)	22	
P49	night mode ending point	0-23 (time)	6	

Remarks:

1. The Parameter P21~P25 are different for different modles, it can only be set during the production. You have to keep it during your setting on the work

site.

In case reset all the parameters, the below points have to be reset according to below table for different model, otherwise the unit can not work properly.

Correct Parameter value

Code	Meaning	Range	9KW Correct value	11KW Correct value	16KW Correct value
P21	EEV manual open degree (heating) /2	50~240	180	200	180
P22	EEV manual open degree (cooling)/2	50~240	150	180	150
P23	EEV control method	0-No; 1-check;2-manual;3-auto	3	3	3
P24	EEV Temp differential to stop the valve (heating)	-5~10°C	3°C	1°C	2°C
P25	EEV temp differential to stop the valve (cooling)	-5~10°C	2°C	1°C	4°C
P26	water pump working method	0 (no stop); 1 reach temp stop, 2 stop for 15 mins on 1 min	0	0	0

2. **forced anti bacterial, press M key for 5 seconds. With a beep, anti bacterial mode works with the setting temp.**

hot water >= anti bacterial setting, exit

3. **parameter reset: press wire controller**  for 5seconds, with a beep, parameter reset, indoor PCB need to power off and on again to make the change valid. parameter reset to default.

4. **functional parameter P14: When parameter valve =1** : when unit working with AC heating, compare solar water tank temp and AC return temp,

When solar water tank temp – AC return water temp ≥5°C, electrical three valve G3 ON; when < 2°C, electrical 3 way valve G3 OFF。 When P14=0, G3 is seasonal valve, AC heating mode, G3 ON; AC cooling mode, G3 OFF。

4.7 function DIPswitch: SW1 (after changes, will be valid after power resupply only)

SW1-1	OFF: water source ; ON: air source
SW1-2	OFF: AC heating control mode 1; ON: AC heating control mode 2
SW1-3	reserved
SW1-4	OFF: inverter outdoor; ON: fix speed outdoor
SW1-5	Reserved
SW1-6	OFF: DHW valid; ON: DHW not valid
SW1-7	OFF: heating valid ; ON: heating not valid
SW1-8	OFF: cooling valid; ON: cooling not valid

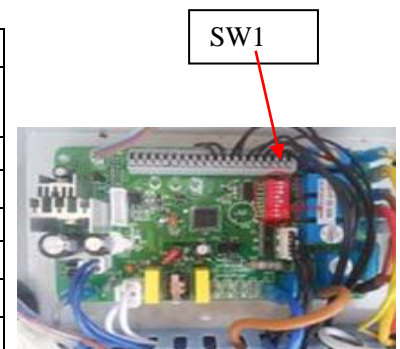

4. 8 (Only checkable parameter list)

press wire controller M + ▼ keys for 3S, it will show Cx to check the above parameter

No	name	Range / meaning	remark
00	out pipe temp	-30~97℃	
01	compressor discharge temp	-30~128℃	
02	ambient temp	-30~97℃	Calculation parameter D
03	AC leaving water temp	-30~97℃	
04	hot water pipe temp	-30~97℃	
05	solar pipe temp	-30~97℃	
06	DIP switch input state	0 (cooling only); 1 (heating only)	
07	DIP switch input state	0 (air source); 1 (water source)	
08	DIP switch input state	0 (DHW invalid); 1 (DHW valid)	
09	DIP switch input state	0 (G1 valid); 1 (G1invalid)	
10	high pressure switch state	1 (On); 0 (Off)	
11	over current protection switch	1 (on); 0 (off) not valid	
12	low pressure switch state	1 (on); 0 (off)	
13	inner water flow switch (for AH, GH)	1 (on); 0 (off)	
14	external water flow switch (for GH)	1 (on); 0 (off)	
15	second high pressure switch state	1 (on); 0 (off)	
19	compressor running Hz	Inverter: Show actual frequency	
20	outdoor fan motor	1: running; 0: stop	
21	bent axle heater	1: on; 0: off	
22	four way valve	1: on; 0: off	
23	bypass valve	1: on; 0: off	
24	1 electrical valve	1: on; 0: off	
25	2 electrical valve	1: on; 0: off	
26	3 electrical valve	1: on; 0: off	
27	1 electrical heater 1	1: on; 0: off	
28	2 electrical heater 2	1: on; 0: off	
29	C4 water pump	1: on; 0: off	
30	C5 water pump	1: on; 0: off	
31	C6 water pump	1: on; 0: off	
32	accumulation days since last antibacterial	0-99	
33	cooling setting temp	Real setting temp	
34	heating setting temp	Real setting temp	
35	hot water setting temp	Real setting temp	
36	anti bacterial setting temp	Real setting temp	
37	outdoor modular temp	-30~97℃	
38	outdoor back temp	-30~97℃	
39	inner pipe temp	-30~97℃	
40	expansion valve open degree		
41	water source side inlet water temp	-30~97℃	
42	water side leaving temp	-30~97℃	
43	solar water tank temp	-30~97℃	
44	inner pipe temp	Entrance of the plate heat exchanger	
45	room temp display		
46	Home optimization target temp		Calculation parameter A

5. TECHNICAL SPECIFICATION

5.1 Internal View

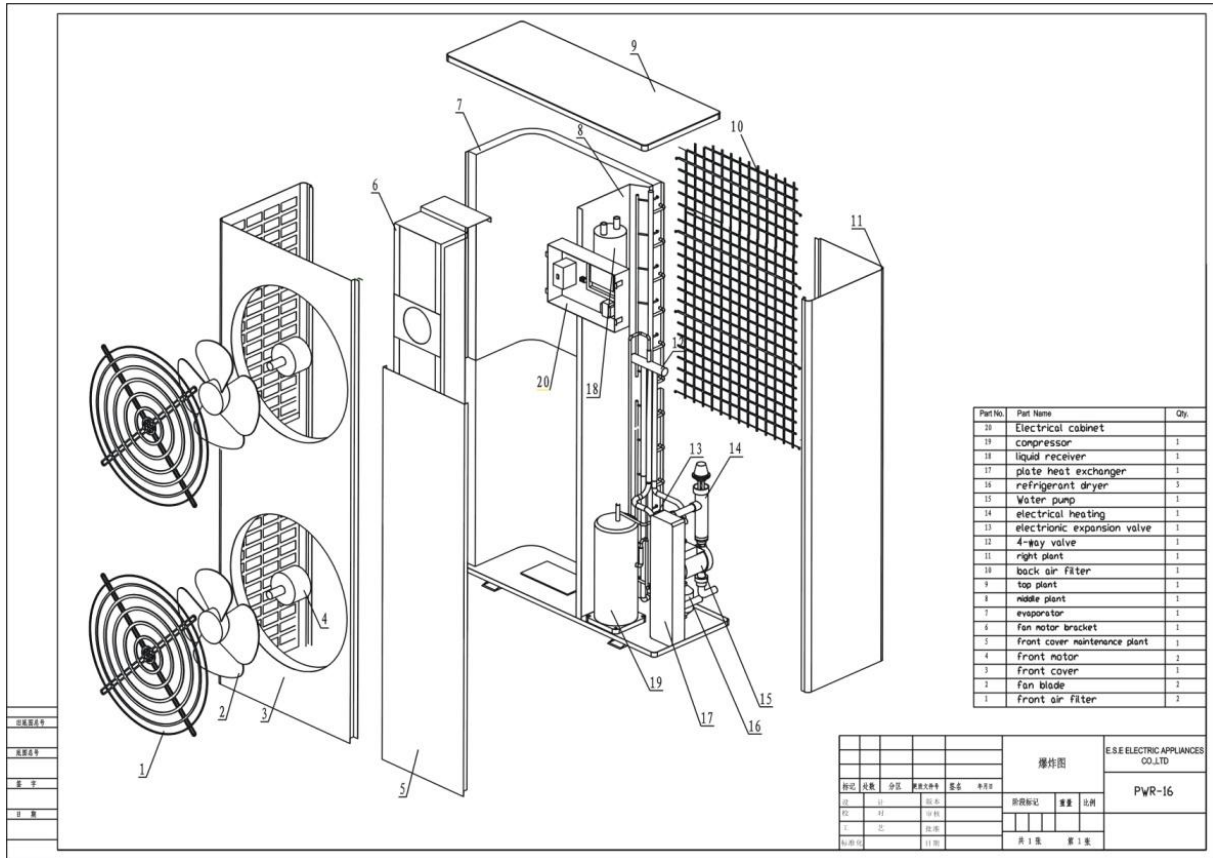

5.2 System Drawing AH9/11/16/17S/23S

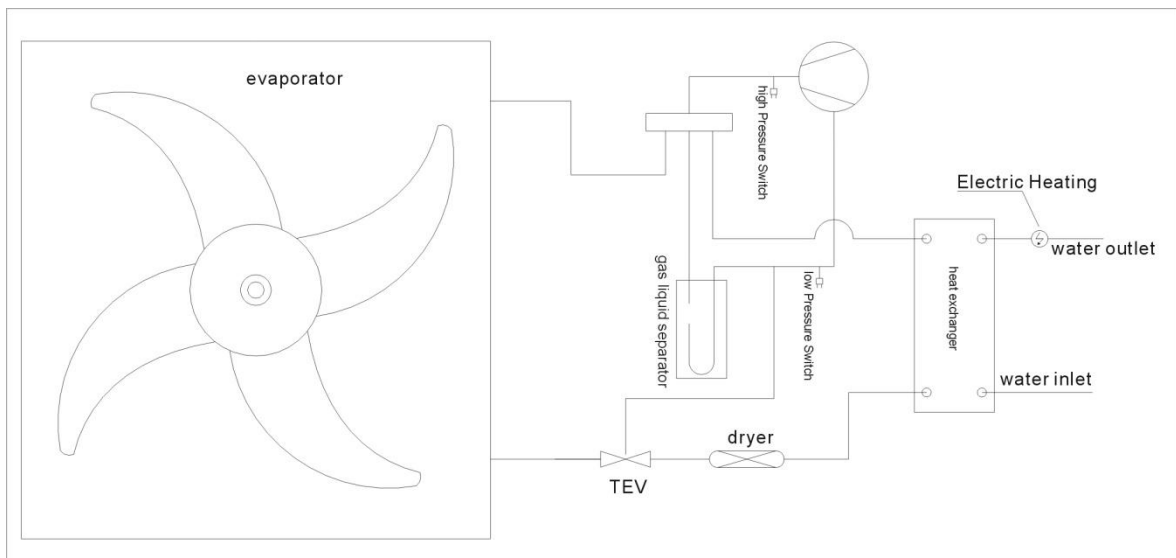

5.3 Dimensions:

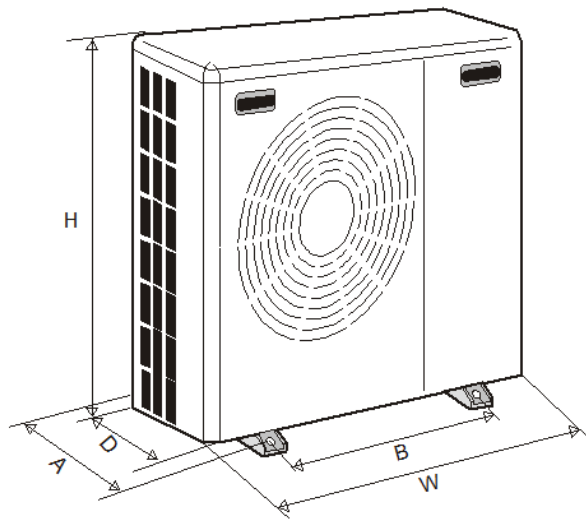

Model	9
W	1090
D	420
H	780
A	440
B	810

16/17S

1280mm (for 16/17S)
1462mm (for 23S)

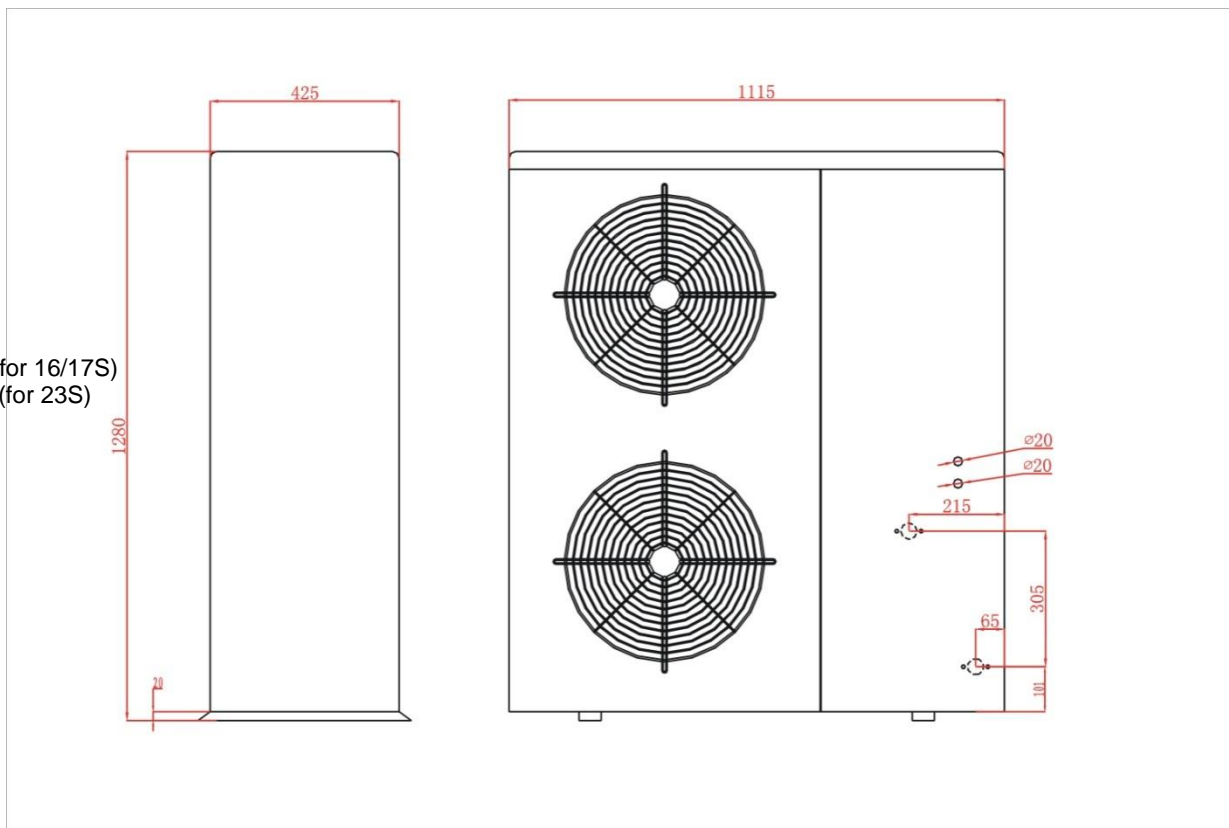

6. Maintenance

6.1 Maintenance and Cleaning for User

It is good practice to inspect your heat pump regularly. Maintenance should be carried out at least annually to maintain a good lifespan of your heat pump.

1. Regularly clean the Y type filters every 6 months to ensure that the system is clean and to avoid blockage to the system.
2. Units should be kept clean (no leaves or dirt) and no obstructions should be placed in front of or behind the unit. Good ventilation and regular cleaning (3-6 months) of the evaporator will help maintain efficiency.
3. Ensure the unit has power in the winter whether the unit is used or not.

6.2 Maintenance for Specialist

1. Check the power unit and electrical system.
2. Check the water system, safety valves and exhaust devices are working properly so as not to pump air into the system causing reduced circulation.
3. Check water pump is functioning properly. Make sure the water pipeline and pipe fittings are not leaking.
4. Clear evaporator of any debris.
5. Check the various components of the unit work properly. Inspect the pipe joints and valves branch have inflated oil, to ensure no leakage of the refrigerant unit.
6. Chemically flush the plate heat exchanger after every 3 years.
7. Check refrigerant gas content if necessary.
8. Check delta (water in/out) making it meets the guidelines of delta 3 to 7.

7. How To Get The Most Out Of Your Heat Pump

It is important to understand that you should operate heat pumps differently to conventional heating systems such as gas boilers. Below are some points you should be aware of:

- Since heat pumps produce water at a lower temperature (than gas boilers), it is important to remember the heat up time of your property is slower.
- The lower temperature the heat pump produces, the more efficient it is.
- The higher the ambient temperature (outside temperature), the more efficient the heat pump is.
- The heat pump has a simple job, and that is to maintain the water tanks at the set temperature.
- It's a good idea to let your heat pump maintain your water tank temperatures 24 hours a day during the winter. This will enable your central heating controller to call for heat in the home at any time. During the summer you can set the timer on the heat pump controller for your hot water requirements.

With the above in mind, you could decide between the following:

Option 1. You could decide to operate your heat pump during the day time (when temperatures are higher). At the same time you could set the water temperature lower. This will basically charge your home during the day so in the evening the home is warm and the heat pump simply maintains the heat. This is not controlled by the heat pump controller, it is controlled by your central heating controller.

Option 2. You could operate your central heating controller in a similar way to a conventional boiler. You must set the programme at least 1 hour before you need your property to be warm. The downside to this is that you may need to set the water that the heat pump produces to a higher temperature.

Option 3. You could decide to operate your home with back ground heat. This means you are always (24 hours a day) putting a trickle heat in your home

In all cases it is recommended to maintain a minimum temperature in your home (e.g. 14c to16C) during the evening. This is controlled by your central heating controller.

There is no right and wrong way to operate your heat pump. We cannot tell you which is the most efficient way to operate it since every home is different. What we can say is that you should look for the best way to heat your home that suits your lifestyle. Nowadays with low cost energy monitors, you can easily find the most cost effective way to heat your home. We hope you enjoy your Heat Pump.